

PPU INSERTS + VORTEX BAR

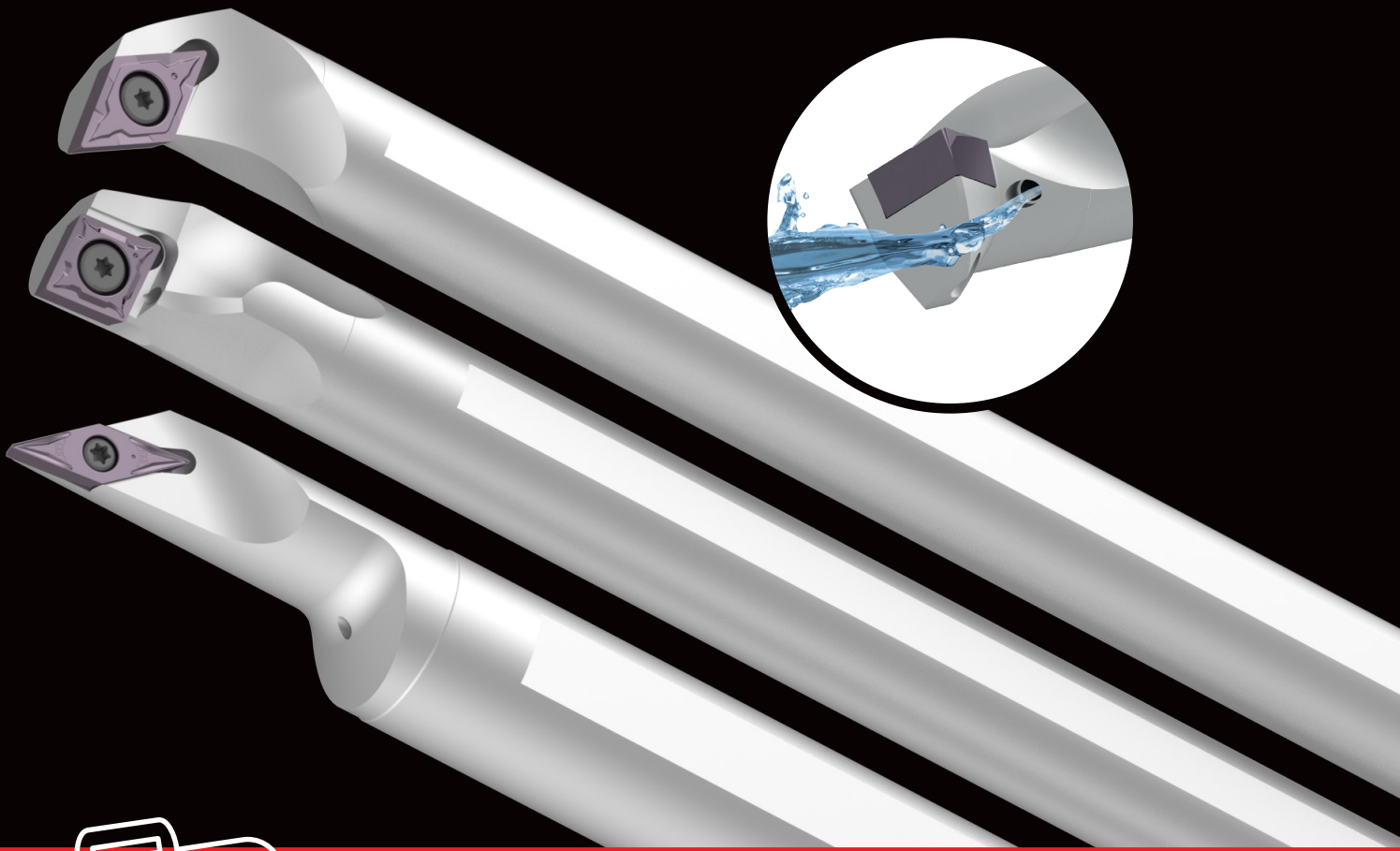

SPECIAL
KIT Action

Plaquitas PPU + Vortex Bar
Soluciones para el mandrinado de precisión
(incluido el acabado con corte interrumpido y
el mandrinado de paredes finas)

nikkoTOOLS
SORMA CUTTING SOLUTIONS

PPU INSERTS + VORTEX BAR

nikkoTOOLS
SORMA CUTTING SOLUTIONS

**SPECIAL
KIT**



¡Prueba Vortex Bar + PPU!

Cada kit incluye 4 Vortex Bar y 10 plaquitas PPU

<h1>R</h1> <p>DMIN</p>	1 x NT-V10K-SCLCR06-12 (Ø10)	<p>INTERNAL COOLANT</p>	12
	1 x NT-V12M-SCLCR06-14 (Ø12)		14
	1 x NT-V16Q-SCLCR09-18 (Ø16)		18
	1 x NT-V20R-SCLCR09-22 (Ø20)		22
	<p>5 x CCGT060204-PPU 5 x CCGT09T304-PPU</p> <p>JP5125 U-VORTEX-CC01R</p>		
<h1>L</h1> <p>DMIN</p>	1 x NT-V10K-SCLCL06-12 (Ø10)	<p>INTERNAL COOLANT</p>	12
	1 x NT-V12M-SCLCL06-14 (Ø12)		14
	1 x NT-V16Q-SCLCL09-18 (Ø16)		18
	1 x NT-V20R-SCLCL09-22 (Ø20)		22
	<p>5 x CCGT060204-PPU 5 x CCGT09T304-PPU</p> <p>JP5125 U-VORTEX-CC01L</p>		
<h1>R</h1> <p>DMIN</p>	1 x NT-V10K-SDUCR07-14 (Ø10)	<p>INTERNAL COOLANT</p>	14
	1 x NT-V12M-SDUCR07-16 (Ø12)		16
	1 x NT-V16Q-SDUCR11-23 (Ø16)		23
	1 x NT-V20R-SDUCR11-27 (Ø20)		27
	<p>5 x DCGT070204-PPU 5 x DCGT11T304-PPU</p> <p>JP5125 U-VORTEX-DC01R</p>		
<h1>L</h1> <p>DMIN</p>	1 x NT-V10K-SDUCL07-14 (Ø10)	<p>INTERNAL COOLANT</p>	14
	1 x NT-V12M-SDUCL07-16 (Ø12)		16
	1 x NT-V16Q-SDUCL11-23 (Ø16)		23
	1 x NT-V20R-SDUCL11-27 (Ø20)		27
	<p>5 x DCGT070204-PPU 5 x DCGT11T304-PPU</p> <p>JP5125 U-VORTEX-DC01L</p>		

PPU INSERTS + VORTEX BAR



nikkoTOOLS
SORMA CUTTING SOLUTIONS

239,00
euros



¡Prueba Vortex Bar + PPU!

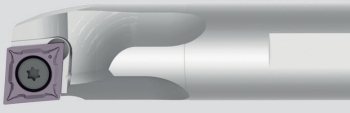
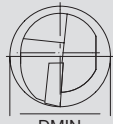

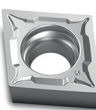
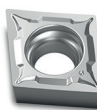



Cada kit incluye 3 Vortex Bar y 10 plaquitas PPU

R								
				DMIN				
1 x NT-V08H-SCLCR06-10 (Ø8)			INTERNAL COOLANT 	10	INTERNAL COOLANT 	10		
1 x NT-V10K-SCLCR06-12 (Ø10)		12		12				
1 x NT-V12M-SCLCR06-14 (Ø12)		14		14				
	10 x CCGT060204-PPU	JP5125	U-VORTEX-3CCR			10 x CCGT060204-PPU	JP5125	U-VORTEX-3CCL

299,00
euros



Cada kit incluye 2 Vortex Bar y 10 plaquitas PPU

R								
				DMIN				
1 x NT-V20R-SVJBR11-25 (Ø20)			INTERNAL COOLANT 	25	INTERNAL COOLANT 	25		
1 x NT-V25S-SVJBR11-30 (Ø25)		30		30				
	10 x VCGT110304-PPU	JP5125	U-VORTEX-VC01R			10 x VCGT110304-PPU	JP5125	U-VORTEX-VC01L

¿Por qué escoger Vortex Bar?

- El diseño especial de las ranuras mejora la expulsión de virutas
- Acero de alta calidad que reduce las vibraciones, también en caso de gran voladizo (hasta 5xD)
- Canales de refrigeración internos en toda la gama

¿Por qué escoger las plaquitas PPU?

- Geometría muy robusta con baja fuerza de corte, fiable y no deforma la pieza; reduce las vibraciones en las aplicaciones de mandrinado
- Calidad resistente al calor específica para acero inoxidable y superaleaciones, fiabilidad duradera
- La combinación optimizada de la geometría y el grado supera múltiples retos, como el mandrinado interrumpido de precisión de paredes finas
- Solución universal, apta tanto en aplicaciones difíciles como en el mecanizado convencional



Productos distribuidos por

Sorma Ibérica Tools S.L

Frederic Mompou 4/A

08960 Sant Just Desvern, Barcelona - España

tel. +34 93.793.27.11 - info@sormaiberica.com

www.sormaiberica.com



\$NKKITPPU+SPA