

PPU INSERTS + VORTEX BAR

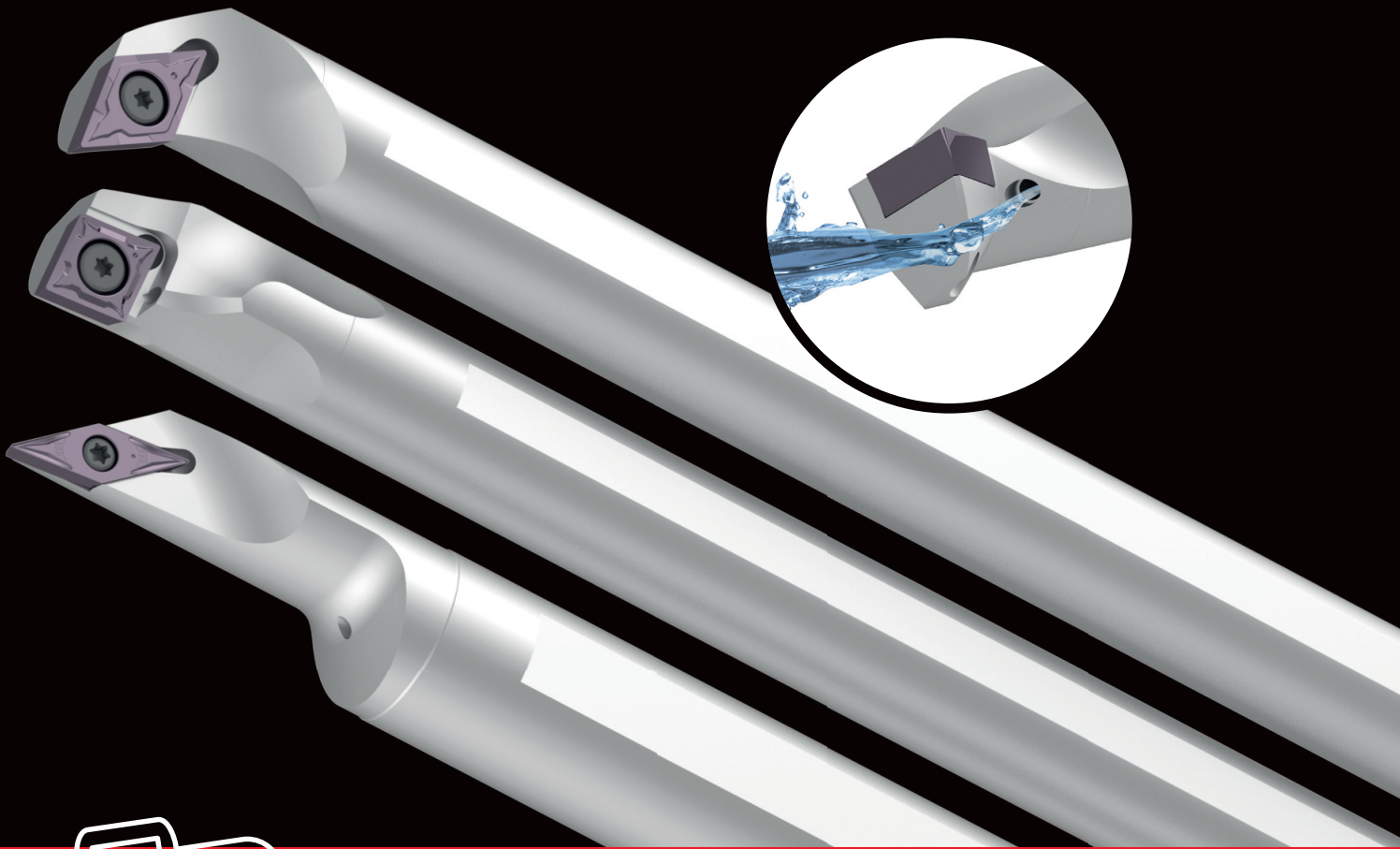

SPECIAL
KIT Action

PPU Inserts with Vortex Bar
Solution package for precision boring
(including interrupted cut finishing
& thin wall boring)

nikkoTOOLS
SORMA CUTTING SOLUTIONS

PPU INSERTS + VORTEX BAR





nikkoTOOLS
SORMA CUTTING SOLUTIONS



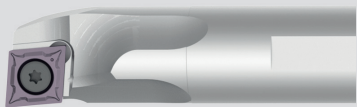

**SPECIAL
KIT**





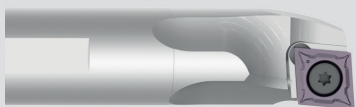



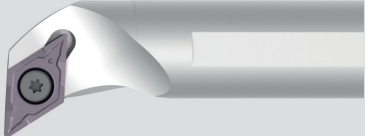

Try Vortex Bar + PPU inserts!

Each kit includes 4 Vortex bars and 10 PPU inserts

R			INTERNAL COOLANT 
	1 x NT-V10K-SCLCR06-12 (Ø10)	12	
	1 x NT-V12M-SCLCR06-14 (Ø12)	14	
	1 x NT-V16Q-SCLCR09-18 (Ø16)	18	
	1 x NT-V20R-SCLCR09-22 (Ø20)	22	
	5 x CCGT060204-PPU 5 x CCGT09T304-PPU	JP5125 U-VORTEX-CC01R	

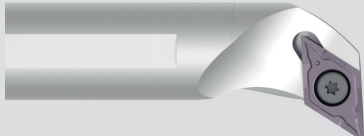
L			INTERNAL COOLANT 
	1 x NT-V10K-SCLCL06-12 (Ø10)	12	
	1 x NT-V12M-SCLCL06-14 (Ø12)	14	
	1 x NT-V16Q-SCLCL09-18 (Ø16)	18	
	1 x NT-V20R-SCLCL09-22 (Ø20)	22	
	5 x CCGT060204-PPU 5 x CCGT09T304-PPU	JP5125 U-VORTEX-CC01L	

R			INTERNAL COOLANT 
	1 x NT-V10K-SDUCR07-14 (Ø10)	14	
	1 x NT-V12M-SDUCR07-16 (Ø12)	16	
	1 x NT-V16Q-SDUCR11-23 (Ø16)	23	
	1 x NT-V20R-SDUCR11-27 (Ø20)	27	
	5 x DCGT070204-PPU 5 x DCGT11T304-PPU	JP5125 U-VORTEX-DC01R	





L			INTERNAL COOLANT 
	1 x NT-V10K-SDUCL07-14 (Ø10)	14	
	1 x NT-V12M-SDUCL07-16 (Ø12)	16	
	1 x NT-V16Q-SDUCL11-23 (Ø16)	23	
	1 x NT-V20R-SDUCL11-27 (Ø20)	27	
	5 x DCGT070204-PPU 5 x DCGT11T304-PPU	JP5125 U-VORTEX-DC01L	



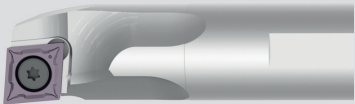

PPU INSERTS + VORTEX BAR



Try Vortex Bar + PPU inserts!





Each kit includes 3 Vortex bars and 10 PPU inserts





R			INTERNAL COOLANT 	DMIN
	1 x NT-V08H-SCLCR06-10 (Ø8)	10		
	1 x NT-V10K-SCLCR06-12 (Ø10)	12		
	1 x NT-V12M-SCLCR06-14 (Ø12)	14		
	10 x CCGT060204-PPU	JP5125	U-VORTEX-3CCR	

L			INTERNAL COOLANT 	DMIN
	1 x NT-V08H-SCLCL06-10 (Ø8)	10		
	1 x NT-V10K-SCLCL06-12 (Ø10)	12		
	1 x NT-V12M-SCLCL06-14 (Ø12)	14		
	10 x CCGT060204-PPU	JP5125	U-VORTEX-3CCL	



Each kit includes 2 Vortex bars and 10 PPU inserts

R			INTERNAL COOLANT 	DMIN
	1 x NT-V20R-SVJBR11-25 (Ø20)	25		
	1 x NT-V25S-SVJBR11-30 (Ø25)	30		
		10 x VCGT110304-PPU		

L			INTERNAL COOLANT 	DMIN
	1 x NT-V20R-SVJBL11-25 (Ø20)	25		
	1 x NT-V25S-SVJBL11-30 (Ø25)	30		
		10 x VCGT110304-PPU		

Why choosing Vortex Bar?

- Special chip groove design improves chip ejection
- High quality steel reduces vibration even with significant overhang (max 5XD)
- Internal coolant channels on the full line-up

Why choosing PPU inserts?

- Very robust geometry with low cutting force, reliable, avoids the deformation of the part and reduces vibration in boring application
- Heat resistant grade specific for stainless steel and super alloys, provides long-lasting reliability
- Optimized coupling of the geometry and the grade allowing to win multiple challenges, such as precision interrupted boring of thin walls
- Universal solution, fits from difficult application to conventional machining



Via Don F. Tosatto, 8
30174 Mestre - Venezia
+39 041.959179
info@nikkotools.com

www.nikkotools.com

